

# Standard Heat Sinks

Suggested hole patterns:

DEVICE	PATTERN
TO-3	01E
TO-220	14X
TO-220-2	14A
TO-66	03B

Other hole patterns available.  
See pages 27-32.

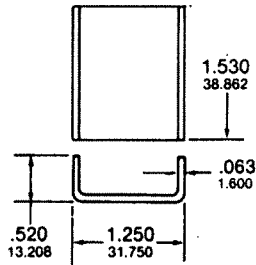

Material... 1100-H14 Aluminum  
Finish..... Black Anodize

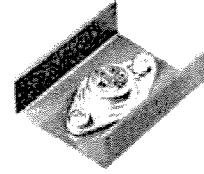
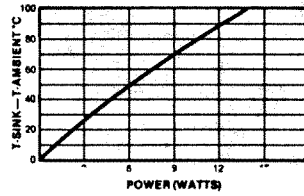

7-335

C

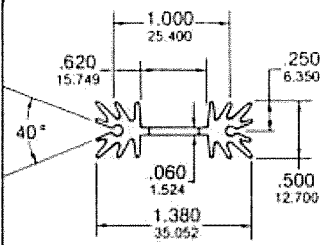

7-338

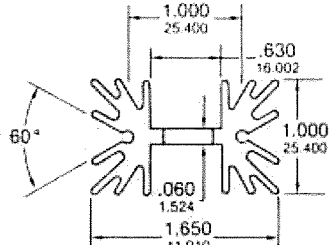

7-339

Tin-plated steel roll pins for solder mount

Material... 6063-T5 aluminum  
Finish..... Black Anodize

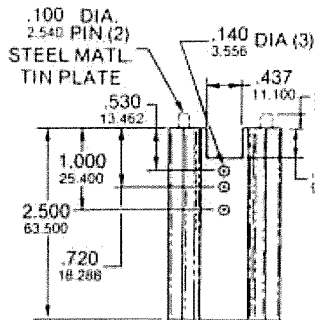
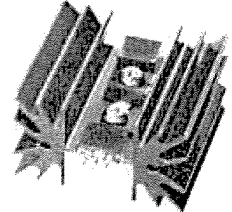
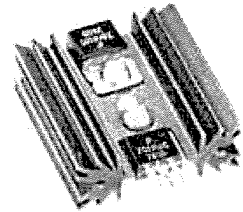
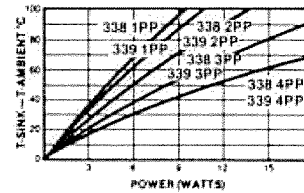

4PP

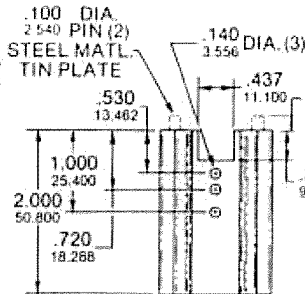

3PP

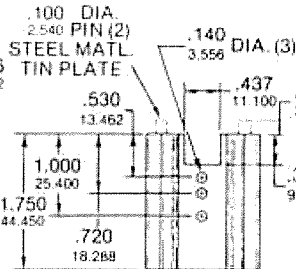

2PP



1PP

7-338 & 7-339  
-1,-2,-3,-4

## Low Power

